



# Russell Hobbs



**18780**

 [www.russellhobbs.com](http://www.russellhobbs.com)

**Register online for an EXTRA year guarantee**

Visit [www.russellhobbs.co.uk/productregister/](http://www.russellhobbs.co.uk/productregister/) You must register within 28 days of purchase

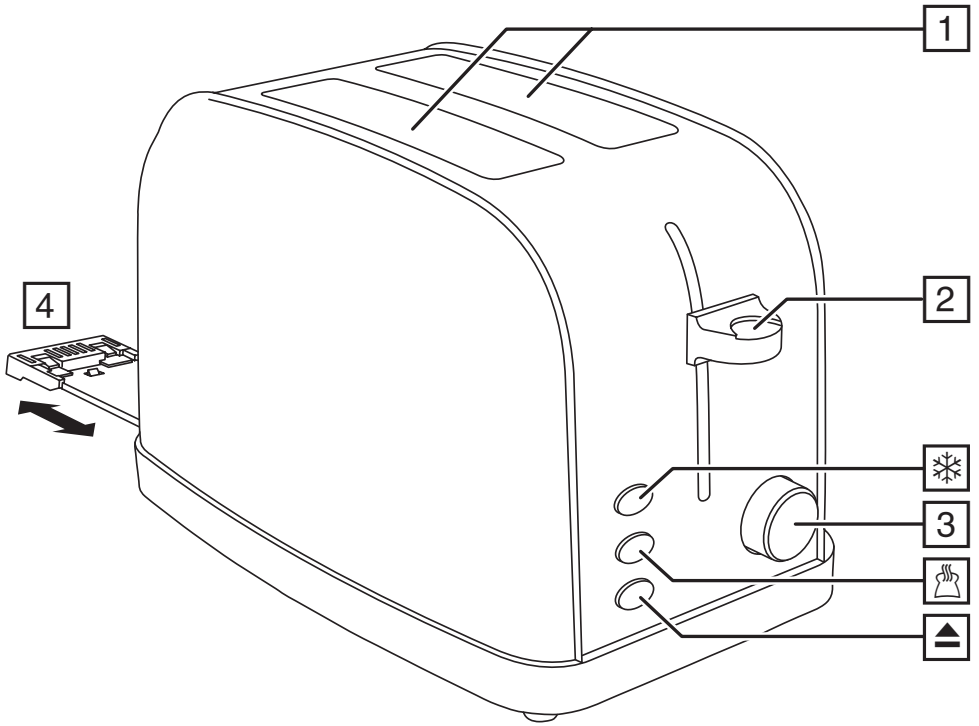

Read the instructions, keep them safe, pass them on if you pass the appliance on. Remove all packaging before use.

---

## IMPORTANT SAFEGUARDS

Follow basic safety precautions, including:

This appliance can be used by children aged from 8 years and above and persons with reduced physical, sensory or mental capabilities or lack of experience and knowledge if they have been given supervision or instruction concerning use of the appliance in a safe way and understand the hazards involved. Children shall not play with the appliance. Cleaning and user maintenance shall not be done by children unless they are older than 8 and supervised.

Keep the appliance and its cord out of reach of children less than 8 years old.

Don't connect the appliance via a timer or remote control system.

Bread may burn. Don't use the toaster near or below combustible materials such as curtains.

 The surfaces of the appliance will get hot during use.

Unplug the appliance and let it cool. Remove and empty the crumb tray. Wipe with a damp cloth, dry, then replace in the toaster. Don't operate the toaster without the crumb tray fitted.

If the cable is damaged, return the appliance, to avoid hazard.

-  Do not use this appliance near bathtubs, showers, basins or other vessels containing water.
- When using a single toasting slot, check that the other slot is empty.
- Don't toast or reheat buttered, torn, or misshapen bread.
- If bread gets jammed, unplug the toaster, let it cool, and carefully remove the bread.
- Don't use the appliance for any purposes other than those described in these instructions.
- Route the cable so it doesn't overhang, and can't be tripped over or caught.
- Don't cover the appliance or put anything on top of it.
- Don't operate the appliance if it's damaged or malfunctions.

## HOUSEHOLD USE ONLY

---

### PARTS

- |                   |                     |
|-------------------|---------------------|
| 1. Toasting slots | 3. Browning control |
| 2. Lever          | 4. Crumb tray       |



---

## BEFORE USING FOR THE FIRST TIME

1. Set the browning level to maximum (7).
2. Operate the appliance empty, to cure the new elements.
3. This may smell a bit, but it's nothing to worry about. Ensure the room is well ventilated.



---

## TOASTING BREAD

1. Place the toaster upright on a firm, level, heat-resistant surface.
  2. Put the plug into the power socket.
  3. Turn the browning control to the required setting (1 = light, 7 = dark).
  4. Put bread into the toasting slots (maximum thickness 26mm).
  5. Press the lever down fully. It won't lock down unless the toaster is connected to the electricity supply.
  6. The  light will come on and the elements will heat up.
  7. When it's done, the toast will pop up.
  8. To stop toasting, press .
- After toasting small items (bagels, crumpets, etc.) the lever may be raised further, to allow them to be removed more easily.



---

## FROZEN BREAD

1. Leave the browning level at your favoured setting, insert the frozen bread, lower the lever, then press .
2. The  light will come on and the toasting time will be altered automatically to give the same degree of browning you get with unfrozen bread.

---

## REHEATING TOAST

1. Leave the browning control at your favoured setting, insert the bread, lower the lever, then press .
2. The  light will come on and the toast will be given a short burst of heat.
3. Don't reheat buttered, torn, or misshapen bread.

---

## HINTS AND TIPS

- Old bread has less moisture, so makes crisper toast.
- Old bread, thin slices, and sweet bread products (tea cakes, fruit loaf, etc.) brown faster so use a lower setting.

---

## CARE AND MAINTENANCE

- Unplug the toaster and let it cool down.
- Wipe the outer surfaces with a damp cloth.







---

## RECYCLING



To avoid environmental and health problems due to hazardous substances, appliances and rechargeable and non-rechargeable batteries marked with one of these symbols must not be disposed of with unsorted municipal waste. Always dispose of electrical and electronic products and, where applicable, rechargeable and non-rechargeable batteries, at an appropriate official recycling/collection point.

---

## SERVICE

If you ring Customer Service, please have the Model Number to hand, as we won't be able to help you without it. It's on the rating plate (usually underneath the product).

The product isn't user-serviceable. If it's not working, read the instructions, check the plug fuse and main fuse/circuit breaker. If it's still not working, consult your retailer.

If that doesn't solve the problem – ring Customer Service – they may be able to offer technical advice.

If they advise you to return the product to us, pack it carefully, include a note with your name, address, day phone number, and what's wrong. If under guarantee, say where and when purchased, and include proof of purchase (till receipt). Send it to:

Customer Service

Spectrum Brands (UK) Ltd

Fir Street, Failsworth, Manchester M35 0HS

email: [support@russellhobbs.com](mailto:support@russellhobbs.com)

telephone: 0345 658 9700 (local rate number)

Please note: If you have purchased the product within the last 6 months, please contact the retailer in the first instance to deal with any matters relating to warranty.

---

## GUARANTEE

Defects affecting product functionality appearing within the guarantee period will be corrected by replacement or repair at our option provided the product is used and maintained in accordance with the instructions. Your statutory rights are not affected.

Guarantee period = 2 years from first retail purchase.

To claim an extra 1 year guarantee, register your product online within 28 days of purchase.

Register at: [www.russellhobbs.co.uk/productregister/](http://www.russellhobbs.co.uk/productregister/)

Consumables are guaranteed only for their recommended lifecycle. Replacement/Spare parts\* are excluded and are only covered by a 1 year warranty.

\* Examples include filters, removable grill plates, drip trays/crumb trays etc.

---

## ONLINE

[www.russellhobbs.com](http://www.russellhobbs.com) for more products

---

## REGISTER ONLINE

Register online for an EXTRA year guarantee\*.

Visit [www.russellhobbs.co.uk/productregister/](http://www.russellhobbs.co.uk/productregister/)

\*You must register within 28 days of purchase.