



Russell Hobbs



22520

 www.russellhobbs.com

Register online for an EXTRA year guarantee

Visit www.russellhobbs.co.uk/productregister/ You must register within 28 days of purchase

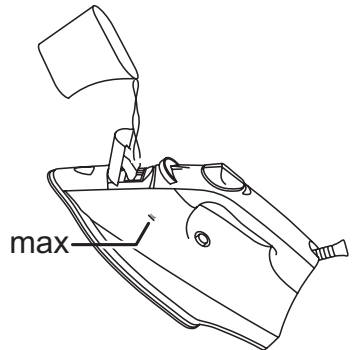
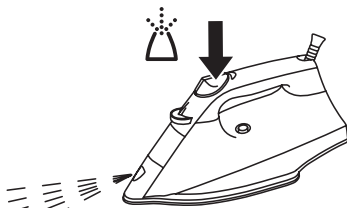
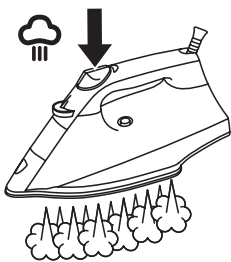
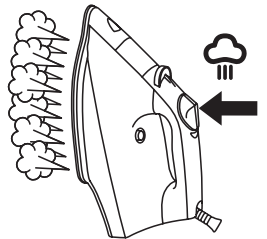
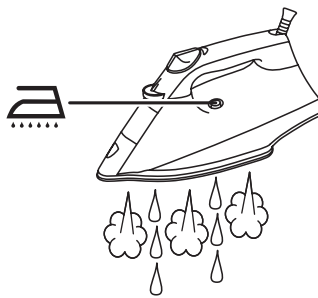
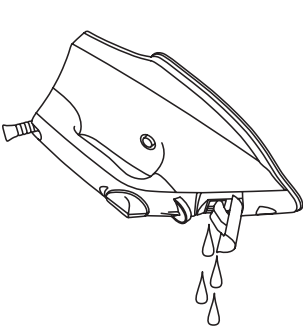
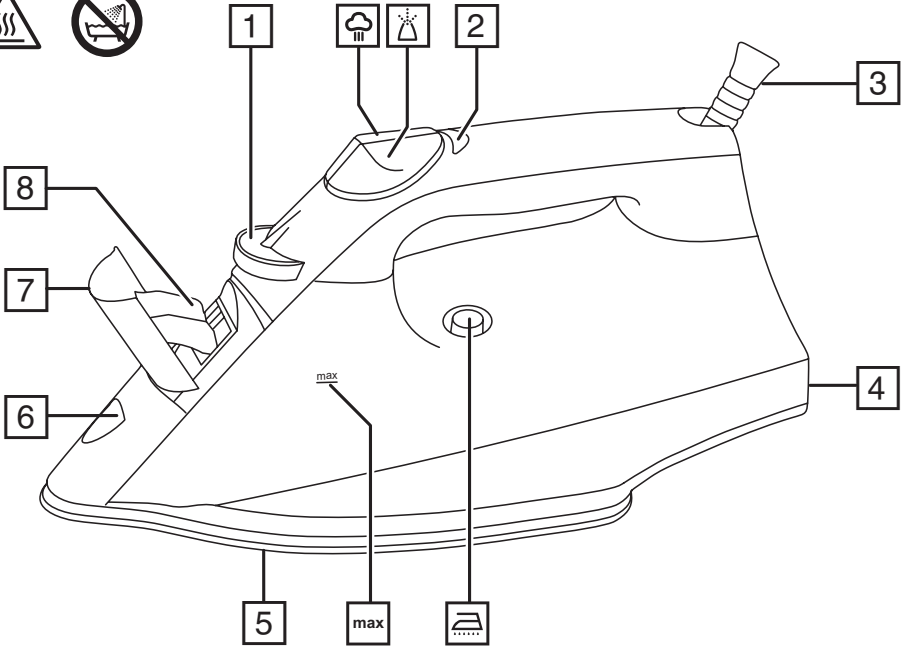

Read the instructions, keep them safe, pass them on if you pass the iron on.

IMPORTANT SAFEGUARDS

Follow basic safety precautions, including:

This appliance can be used by children aged from 8 years and above and persons with reduced physical, sensory or mental capabilities or lack of experience and knowledge if they have been supervised/instructed and understand the hazards involved. Children shall not play with the appliance. Cleaning and user maintenance shall not be done by children unless they are older than 8 and supervised.

Use and store the appliance out of reach of children under 8 years.

Use the iron, or set it on its heel, on a stable, level, heat-resistant surface, preferably an ironing board.

Don't leave the iron unattended while plugged in, or while it's standing on the ironing board.

Unplug the iron before filling, before cleaning, and after use.

Don't operate the appliance if it's dropped or damaged, or if it malfunctions or leaks.

If the cable is damaged, return the iron, to avoid hazard.

 The surfaces of the appliance will get hot during use.

- ⊗ Do not use this appliance near bathtubs, showers, basins or other vessels containing
 - Don't iron clothing while it's being worn – you'll injure the wearer.
 - Don't use the appliance for any purpose other than those described in these instructions.
 - Don't scratch the soleplate – avoid buttons, zips, etc.
 - The appliance has a protective thermal fuse, which will blow if it overheats. If this happens, the appliance will stop working, and must be returned for repair.

HOUSEHOLD USE ONLY







PARTS

- | | |
|------------------------|-----------------|
| 1. Temperature control | 5. Soleplate |
| 2. Light | 6. Spray nozzle |
| 3. Swivel cord | 7. Cover |
| 4. Heel | 8. Water inlet |





BEFORE USING FOR THE FIRST TIME

- Remove labels, stickers and packaging from the iron and soleplate.
- Don't worry if the iron smokes a bit at first, it'll stop as the element cures.
- Iron an old piece of cotton fabric, to clean the soleplate.

PREPARATION

1. Check for textile care symbols (   ).
2. Iron fabrics needing low temperatures  first, then those that need medium temperatures , and finish with those needing high temperatures .

TEMPERATURE SETTING GUIDE

Label marking	Dot setting
 cool – nylon, acrylics, polyester	•
 warm – wool, polyester mixtures	••
 hot – cotton, linen	•••
Max – denim	max
 do not iron	-

If the instructions on the fabric label differ from this guide, follow the instructions on the label.

FILLING

You may use the iron with tap-water, but if you live in a hard water area, you should use distilled water (not chemically descaled or softened water).

If you buy distilled water, check that it's suitable for use in irons.

1. Set the temperature control to •.
2. Unplug the iron.
3. Hold the iron with the front raised.
4. Raise the side of the water inlet cover to open it.
5. Pour slowly, to let the air in the reservoir escape, otherwise you'll cause an air lock and the water will overflow.
6. Don't fill past **max**, or water will escape in use.
7. Wipe up any spillage.

SWITCH ON

1. Set the temperature control to •.
2. Sit the iron on its heel.
3. Put the plug into the power socket (switch the socket on, if it's switchable).
4. Turn the temperature control to bring the setting you want next to the mark. The light will come on.
5. When the iron reaches the temperature you set, the light will go off. It'll then cycle on and off as the thermostat operates to maintain the temperature.

STEAM IRONING



1. Steam is available when the temperature control is at  or above.
2. Your iron will adjust the amount of steam automatically.
3. Wait till the light goes out, then start ironing.

SPRAY

Water spotting affects some fabrics. Test this out on a hidden part of the fabric.

1. Lift the iron off the fabric.
2. Aim the spray nozzle at the fabric.
3. Press the  button – you may have to press it 2 or 3 times to pump water through the system.

SHOT OF STEAM

1. Steam is available when the temperature control is at  or above.
2. Lift the iron off the fabric.
3. Press the  button.
4. Leave 4 seconds between shots, to let the temperature build up.

DRY IRONING

If you're going to dry iron you must empty the reservoir first.

1. Unplug the iron
2. Open the water inlet cover.
3. Hold the iron over a sink. Turn it upside down and drain it.
4. Wipe any spillage off the iron before use.
5. Set the temperature.
6. Wait until the light goes out then start ironing.

VERTICAL STEAMING

Remove wrinkles from hanging clothes, hanging curtains, and furnishing fabrics.

- Check that there's adequate ventilation behind the fabric, otherwise moisture may build up, causing mildew.
 - Check that there's nothing behind the fabric that may be damaged by the steam.
 - Check that pockets, turn-ups, and cuffs are empty.
 - Check that there's water in the reservoir.
1. Set the temperature control to **max**.
 2. Hold the iron close to (but not touching) the fabric.
 3. Press the  button (you're using the "shot of steam" function vertically).
 4. Leave 4 seconds between shots, to let the temperature build up.



AFTER USE

1. Set the temperature control to **•**.
2. Unplug the iron.
3. Raise the side of the water inlet cover to open it.
4. Hold the iron over a sink, turn it upside down, and drain the water from the reservoir.
5. Sit the iron on its heel, and leave it to cool down completely.
6. When cold, wipe off any moisture, and close the water inlet cover.
7. Wipe outer surfaces with a damp cloth.
8. Remove spots from the soleplate with a little vinegar – take care not to scratch it.
9. Store the iron on its heel, to avoid corrosion and damage to the soleplate.

SELF CLEAN

To avoid scale build up, use the self clean function at least monthly in normal water areas, more often in hard water areas.

You'll need a basin or a large bowl to catch the water coming out of the soleplate.

1. Fill the reservoir to the **max** mark.
2. Set the temperature control to **max**.
3. Sit the iron on its heel.
4. Put the plug into the power socket and wait till the light goes out.
5. Hold the iron over the basin or bowl with the soleplate down.
6. Press the , and hold it down.
7. Gently move the iron to and fro, over the basin or bowl.
8. Water and steam will wash scale and dust through the soleplate, and into the sink.
9. When the reservoir is empty, release the  button.
10. Unplug the iron, and sit it on its heel to cool.
11. Follow the steps under AFTER USE.

RECYCLING



To avoid environmental and health problems due to hazardous substances, appliances and rechargeable and non-rechargeable batteries marked with one of these symbols must not be disposed of with unsorted municipal waste. Always dispose of electrical and electronic products and, where applicable, rechargeable and non-rechargeable batteries, at an appropriate official recycling/collection point.

SERVICE

If you ring Customer Service, please have the Model Number to hand, as we won't be able to help you without it. It's on the rating plate (usually underneath the product).

The product isn't user-serviceable. If it's not working, read the instructions, check the plug fuse and main fuse/circuit breaker. If it's still not working, consult your retailer.

If that doesn't solve the problem – ring Customer Service – they may be able to offer technical advice.

If they advise you to return the product to us, pack it carefully, include a note with your name, address, day phone number, and what's wrong. If under guarantee, say where and when purchased, and include proof of purchase (till receipt). Send it to:

Customer Service

Spectrum Brands (UK) Ltd

Fir Street, Failsworth, Manchester M35 0HS

email: support@russellhobbs.com

telephone: 0345 658 9700 (local rate number)

Please note: If you have purchased the product within the last 6 months, please contact the retailer in the first instance to deal with any matters relating to warranty.

GUARANTEE

Defects affecting product functionality appearing within the guarantee period will be corrected by replacement or repair at our option provided the product is used and maintained in accordance with the instructions. Your statutory rights are not affected.

Guarantee period = 2 years from first retail purchase.

To claim an extra 1 year guarantee, register your product online within 28 days of purchase.

Register at: www.russellhobbs.co.uk/productregister/

Consumables are guaranteed only for their recommended lifecycle. Replacement/Spare parts* are excluded and are only covered by a 1 year warranty.

* Examples include filters, removable grill plates, drip trays/crumb trays etc.

ONLINE

www.russellhobbs.com for more products

REGISTER ONLINE

Register online for an EXTRA year guarantee*.

Visit www.russellhobbs.co.uk/productregister/

*You must register within 28 days of purchase.