



Russell Hobbs



23300

 www.russellhobbs.com

Register online for an EXTRA year guarantee

Visit www.russellhobbs.co.uk/productregister/ You must register within 28 days of purchase

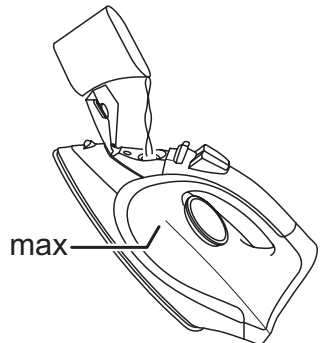
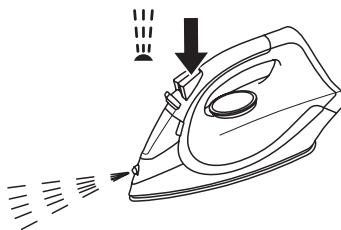
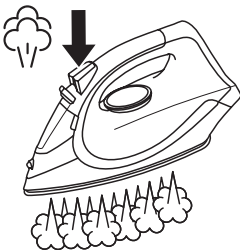
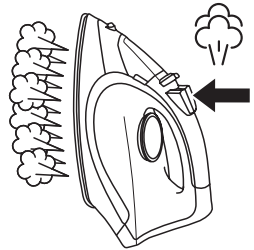
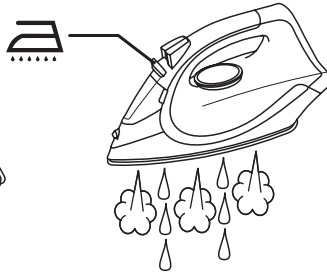
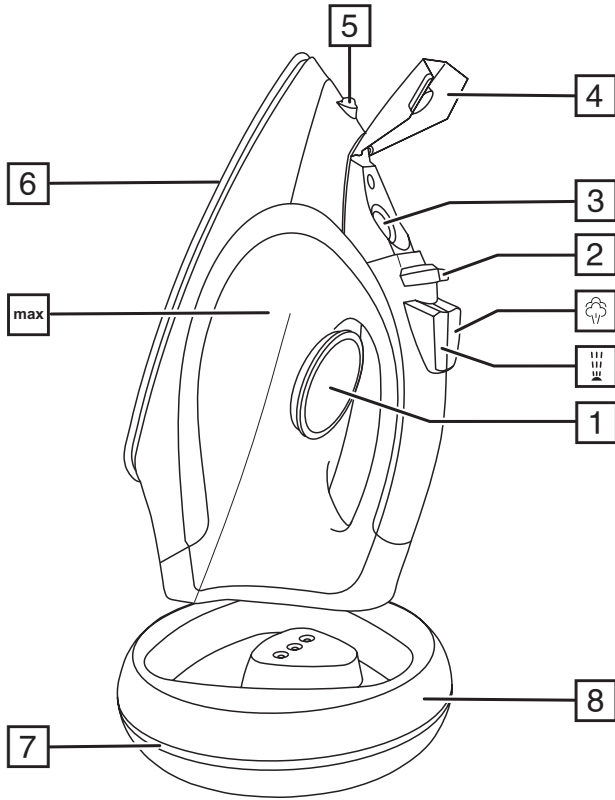

Read the instructions, keep them safe, pass them on if you pass the iron on.

IMPORTANT SAFEGUARDS

Follow basic safety precautions, including:

This appliance can be used by children aged from 8 years and above and persons with reduced physical, sensory or mental capabilities or lack of experience and knowledge if they have been supervised/ instructed and understand the hazards involved. Children shall not play with the appliance. Cleaning and user maintenance shall not be done by children unless they are older than 8 and supervised. Use and store the appliance out of reach of children under 8 years. Keep the iron and its cord out of reach of children less than 8 years of age when it is plugged in or cooling down.

The iron must be used and rested on a flat, stable surface. When placing the iron on its stand, ensure that the surface on which the stand is placed is stable.

The iron must only be used with the stand provided.

Don't leave the iron unattended while plugged in, or while it's standing on the ironing board.

Unplug the iron before filling, before cleaning, and after use.

Don't operate the appliance if it's dropped or damaged, or if it malfunctions or leaks.

If the cable is damaged, return the iron, to avoid hazard.

 The surfaces of the appliance will get hot during use.

-  Do not use this appliance near bathtubs, showers, basins or other vessels containing water.
- Don't iron clothing while it's being worn.
- Don't use the appliance for any purpose other than those described in these instructions.
- Don't scratch the soleplate – avoid buttons, zips, etc.
- The appliance has a protective thermal fuse, which will blow if it overheats. If this happens, the appliance will stop working, and must be returned for repair.

HOUSEHOLD USE ONLY







PARTS

- | | |
|------------------------|-----------------------|
| 1. Temperature control | 5. Spray nozzle |
| 2. Steam control | 6. Soleplate |
| 3. Water inlet | 7. Smart status light |
| 4. Cover | 8. Stand |





BEFORE USING FOR THE FIRST TIME

- Remove labels, stickers and packaging from the iron and soleplate.
- Don't worry if the iron smokes a bit at first, it'll stop as the element cures.
- Iron an old piece of cotton fabric, to clean the soleplate.

PREPARATION

1. Check for textile care symbols (   ).
2. Iron fabrics needing low temperatures  first, then those that need medium temperatures , and finish with those needing high temperatures .

TEMPERATURE SETTING GUIDE

Label marking	Dot setting
 cool – nylon, acrylics, polyester	•
 warm – wool, polyester mixtures	••
 hot – cotton, linen	•••/max
 do not iron	-

If the instructions on the fabric label differ from this guide, follow the instructions on the label.

FILLING

You may use the iron with tap-water, but if you live in a hard water area, you should use distilled water (not chemically descaled or softened water). If you buy distilled water, check that it's suitable for use in irons.

1. Hold the iron with the front raised.
2. Open the water inlet cover.
3. Pour slowly, to let the air in the reservoir escape, otherwise you'll cause an air lock and the water will overflow.
4. Don't fill past **max**, or water will escape during use.
5. Wipe up any spillage.

HEATING YOUR IRON

Your iron is heated by placing it onto the stand. The smart status light will show you when you need to reheat your iron and when it is ready to use. The smart status light operates as follows:

Smart Status Light	Remarks
Steady red	Your iron is heating up
Flashing green	Your iron is ready to use
Flashing red	Your iron needs reheating but you can carry on ironing for a little longer
Flashing red, 3 beeps	Your iron must be reheated as soon as possible
Slowly pulsing red	Auto shut-off activated

Important Note:

Between ironing tasks always put the iron back onto the stand. This ensures the most efficient heating and gives you the best performance from your iron.

1. Set the temperature control to the setting you require.
2. Put the iron onto the stand and plug the stand into the power socket (switch the socket on, if it's switchable). The smart status light will light up red and your iron will start to heat up.
3. When the smart status light flashes green your iron is ready to use.

STEAM IRONING

1. To steam iron, set the temperature control to ☁ or higher.
2. Set the steam control to the setting you want, ☁ = no steam, ☁ = high steam.
3. When the smart status light flashes green your iron is ready to use.

SPRAY

Water spotting affects some fabrics. Test this out first on a hidden part of the fabric.

1. Lift the iron off the fabric.
2. Aim the spray nozzle at the fabric.
3. Press the  button – you may have to press it 2 or 3 times to pump water through the system.

SHOT OF STEAM

1. Steam is available when the temperature control is at ☁ or above.
2. Lift the iron off the fabric.
3. Press the  button.
4. Leave 4 seconds between shots, to let the temperature build up.

DRY IRONING

1. If you're going to be dry ironing for 20 minutes or more, empty the reservoir first, to avoid spontaneous bursts of steam.
2. Set the steam control to .
3. Set the desired temperature.
4. When the smart status light flashes green your iron is ready to use.

VERTICAL STEAMING

Remove wrinkles from hanging clothes, hanging curtains, and furnishing fabrics.

- Check that there's adequate ventilation behind the fabric, otherwise moisture may build up, causing mildew.
 - Check that there's nothing behind the fabric that may be damaged by the steam.
 - Check that pockets, turn-ups, and cuffs are empty.
 - Check that there's water in the reservoir.
1. Set the temperature control to **max**.
 2. Hold the iron close to (but not touching) the fabric.
 3. Press the  button (you're using the "shot of steam" function vertically).
 4. Leave 4 seconds between shots, to let the temperature build up.



AFTER USE

1. Set the temperature control to ●.
2. Unplug the stand.
3. Open the water inlet cover.
4. Hold the iron over a sink, turn it upside down, and drain the water from the reservoir.
5. Sit the iron on the base and leave it to cool down completely.
6. When cold, wipe off any moisture, and close the water inlet cover.
7. Wipe outer surfaces with a damp cloth.
8. Remove spots from the soleplate with a little vinegar – take care not to scratch it.

SELF CLEAN

To avoid scale build up, use the self clean function at least monthly in normal water areas, more often in hard water areas.

You'll need a basin or a large bowl to catch the water coming out of the soleplate.

1. Fill the reservoir to the **max** mark.
2. Set the temperature control to **max**.
3. Sit the iron on the stand.
4. Plug in the stand and wait till the smart status light flashes green.
5. Hold the iron over the basin or bowl with the soleplate down.
6. Move the steam control past  to  and hold it there.
7. Gently move the iron to and fro, over the basin or bowl.
8. Water and steam will wash scale and dust through the soleplate, and into the sink.
9. When water and steam stop coming from the soleplate, release the steam control.
10. Follow the steps under AFTER USE.

AUTO SHUT-OFF

1. If the iron is motionless for about 8 minutes it will switch off.
2. The smart status light will slowly pulse red.
3. To switch on again, lift it off the stand then return it and allow it to heat up again until the smart status light flashes green.

RECYCLING



To avoid environmental and health problems due to hazardous substances, appliances and rechargeable and non-rechargeable batteries marked with one of these symbols must not be disposed of with unsorted municipal waste. Always dispose of electrical and electronic products and, where applicable, rechargeable and non-rechargeable batteries, at an appropriate official recycling/collection point.

SERVICE

If you ring Customer Service, please have the Model Number to hand, as we won't be able to help you without it. It's on the rating plate (usually underneath the product).

The product isn't user-serviceable. If it's not working, read the instructions, check the plug fuse and main fuse/circuit breaker. If it's still not working, consult your retailer.

If that doesn't solve the problem – ring Customer Service – they may be able to offer technical advice.

If they advise you to return the product to us, pack it carefully, include a note with your name, address, day phone number, and what's wrong. If under guarantee, say where and when purchased, and include proof of purchase (till receipt). Send it to:

Customer Service

Spectrum Brands (UK) Ltd

Fir Street, Failsworth, Manchester M35 0HS

email: support@russellhobbs.com

telephone: 0345 658 9700 (local rate number)

Please note: If you have purchased the product within the last 6 months, please contact the retailer in the first instance to deal with any matters relating to warranty.

GUARANTEE

Defects affecting product functionality appearing within the guarantee period will be corrected by replacement or repair at our option provided the product is used and maintained in accordance with the instructions. Your statutory rights are not affected.

Guarantee period = 2 years from first retail purchase.

To claim an extra 1 year guarantee, register your product online within 28 days of purchase.

Register at: www.russellhobbs.co.uk/productregister/

Consumables are guaranteed only for their recommended lifecycle. Replacement/Spare parts* are excluded and are only covered by a 1 year warranty.

* Examples include filters, removable grill plates, drip trays/crumb trays etc.

ONLINE

www.russellhobbs.com for more products

REGISTER ONLINE

Register online for an EXTRA year guarantee*.

Visit www.russellhobbs.co.uk/productregister/

*You must register within 28 days of purchase.