



Russell Hobbs



24391

 www.russellhobbs.com

Register online for an EXTRA year guarantee

Visit uk.russellhobbs.com/product-registration You must register within 28 days of purchase

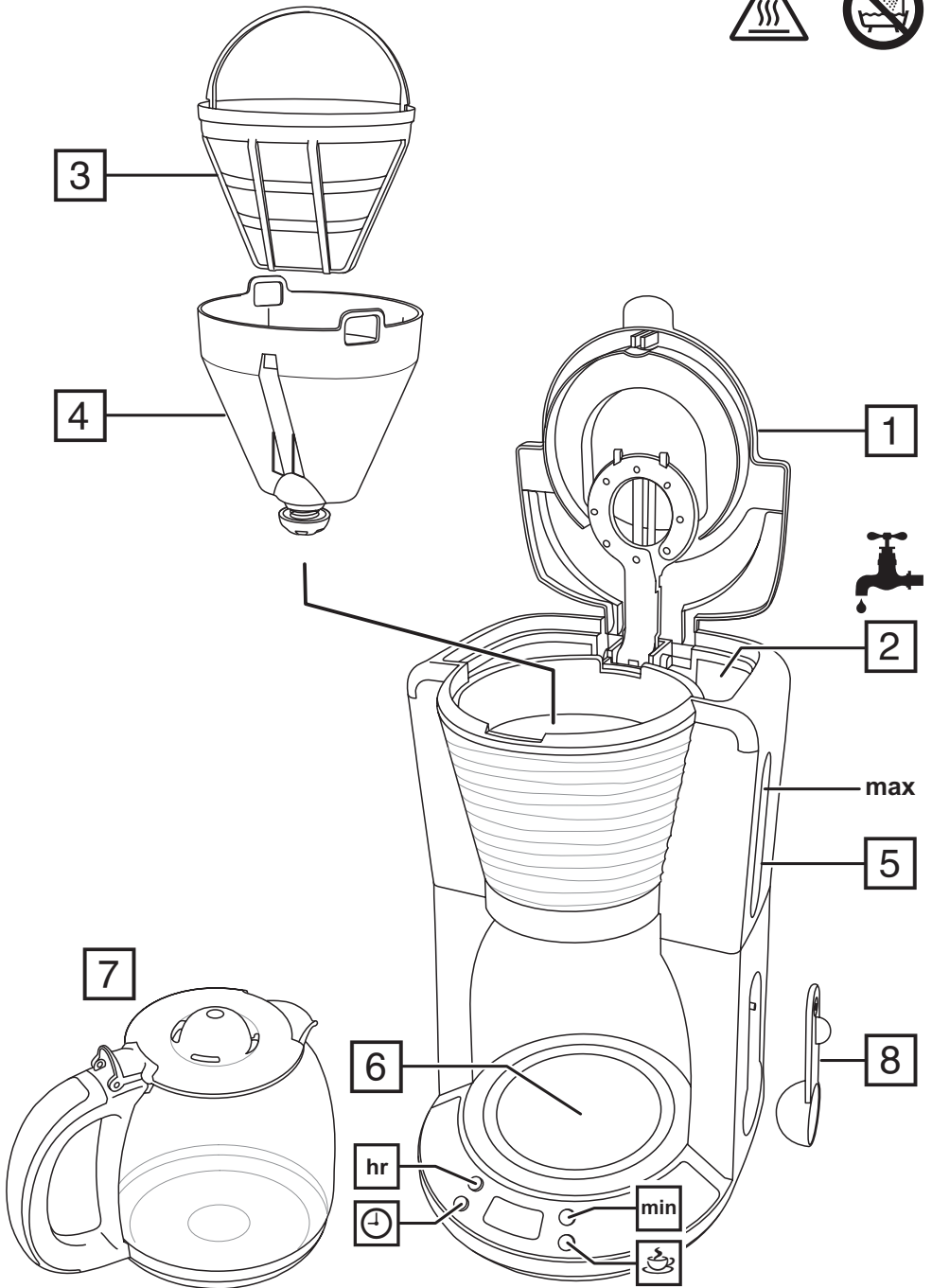

Read the instructions, keep them safe, pass them on if you pass the appliance on. Remove all packaging before use.

IMPORTANT SAFEGUARDS

Follow basic safety precautions, including:

This appliance can be used by children aged from 8 years and above and persons with reduced physical, sensory or mental capabilities or lack of experience and knowledge if they have been supervised/ instructed and understand the hazards involved.

Children shall not play with the appliance.

Cleaning and user maintenance shall not be done by children unless they are older than 8 and supervised.

Keep the appliance and cable out of reach of children under 8 years.

Misuse of the appliance may cause injury.

 The surfaces of the appliance will get hot. Residual heat will keep the surfaces hot after use.

 Do not use this appliance near bathtubs, showers, basins or other vessels containing water.

If the cable is damaged, it must be replaced by the manufacturer, its service agent, or someone similarly qualified, to avoid hazard.

The surface of the heating element is subject to residual heat after use.

Use the appliance according to these instructions. Any misuse may cause potential injury, electric shock or other hazards.

This appliance can be used by persons with reduced physical, sensory or mental capabilities or lack of experience and knowledge if they have been given supervision or instruction concerning use of the appliance in a safe way and understand the hazards involved.

This appliance is intended to be used in household and similar applications such as:

- staff kitchen areas in shops, offices and other working environments;
- by clients in hotels, motels and other residential type environments;
- bed and breakfast type environments;
- farm houses.

- Sit the appliance on a stable, level, heat-resistant surface.
- Keep the appliance and cable away from the edges of worktops.
- Don't use accessories or attachments other than those we supply.
- Don't use the appliance for any purpose other than those described in these instructions.
- Don't use the appliance if it's damaged or malfunctions.

PARTS

- | | |
|---------------------|----------------|
| 1. Lid | 5. Water gauge |
| 2. Water reservoir | 6. Hot plate |
| 3. Permanent filter | 7. Carafe |
| 4. Filter holder | 8. Scoop |

BEFORE USING FOR THE FIRST TIME

Fill the reservoir to the **max** mark, and run the appliance without coffee.

FILLING



1. Remove the carafe from the hotplate.
2. Open the lid.
3. Fill the reservoir with the exact amount of water required. Note that the brewing process will use all of the water that you put in the reservoir.
4. Make sure that the filter holder is pressed down all the way into position. It will click when correctly installed.
5. Put the filter into the filter holder.
6. The reservoir is calibrated to give 10 large cups (at 125ml per cup) and 15 small cups (at 83ml per cup). For each large cup, add 6g of ground filter coffee and for each small cup add 4g.
7. Close the lid.
8. Replace the carafe on the hotplate.

SET THE CLOCK

It isn't necessary to set the clock to use your coffee maker but you will need to set it if you want to use the timer functions.









1. Put the plug into the power socket.
 2. Use the **hr** and **min** buttons to set the correct time in 24 hour format.
- The clock will retain its settings until the coffee maker is unplugged.
 - To change the time, press the  button. The time will flash. Use the **hr** and **min** buttons to set the new time. If you don't press either the **hr** or **min** buttons within 3 seconds, the coffee maker will revert to normal, and the current time will show.

MAKING COFFEE

1. Press the  button – the  icon will appear on the display.
2. Shortly afterwards, coffee will start to drip into the carafe.
3. If you want to stop the coffee maker while it's brewing, press the  button.
4. Once brewed, the hotplate will keep the carafe warm for up to 40 minutes.

USING THE TIMER

Note: Make sure the clock is set to the correct time. Use the **h** and **min** buttons.

1. Set the timer to the time you want to start brewing.
 - a) Press and hold the  button until the  icon flashes on the display.
 - b) Use the **h** and **min** buttons to set the time you want brewing to start. If you don't press either the **hr** or **min** buttons within 3 seconds, the coffee maker will revert to normal, and the current time will show. Press the  button to start again.
2. When the time is programmed, press the  button. The  icon will appear on the display. Your coffee maker is now set to make coffee at the selected time.
- If you want to check the program time press the  button. The programmed time will show for 3 seconds and then return to the time of day.
- If you want to cancel the timer before brewing has started, press the  button.
- If you want to stop the coffee maker while it's brewing, press the  button.

KEEP WARM/AUTO SHUT-OFF

1. Your coffee maker will keep the coffee warm for about 40 minutes.
2. 40 minutes after brewing your coffee maker will shut down and the time of day will be displayed.
3. To wake the appliance, press the **min** button.

A QUICK CUP

If you want a quick cup of coffee before the brewing cycle has finished:

1. You can remove the carafe at any time. The non-drip valve will prevent coffee dripping on to the hotplate.
2. To prevent the filter holder overflowing, replace the carafe on the hotplate within about 20 seconds.
3. When you replace the carafe on the hotplate the non-drip valve opens to let any remaining coffee through.

CARE AND MAINTENANCE

1. Unplug the appliance and let it cool.
2. Tip the contents of the filter holder into the bin.
3. Wipe all surfaces with a clean damp cloth.
4. Press the lever at the rear of the carafe lid to open the carafe lid.
5. Hand wash the carafe, filter and filter holder.
6. Replace the filter and filter holder. Make sure that the filter holder is pressed down all the way into position. It will click when correctly installed.
7. Close the lid, and press down to lock it.

RECYCLING



To avoid environmental and health problems due to hazardous substances, appliances and rechargeable and non-rechargeable batteries marked with one of these symbols must not be disposed of with unsorted municipal waste. Always dispose of electrical and electronic products and, where applicable, rechargeable and non-rechargeable batteries, at an appropriate official recycling/collection point.

SERVICE

If you ring Customer Service, please have the Model Number to hand, as we won't be able to help you without it. It's on the rating plate (usually underneath the product).

The product isn't user-serviceable. If it's not working, read the instructions, check the plug fuse and main fuse/circuit breaker. If it's still not working, consult your retailer.

If that doesn't solve the problem – ring Customer Service – they may be able to offer technical advice.

If they advise you to return the product to us, pack it carefully, include a note with your name, address, day phone number, and what's wrong. If under guarantee, say where and when purchased, and include proof of purchase (till receipt). Send it to:

Customer Service

Spectrum Brands (UK) Ltd

Fir Street, Failsworth, Manchester M35 0HS

email: support@russellhobbs.com

telephone: 0345 658 9700 (local rate number)

Please note: If you have purchased the product within the last 6 months, please contact the retailer in the first instance to deal with any matters relating to warranty.

GUARANTEE

Defects affecting product functionality appearing within the guarantee period will be corrected by replacement or repair at our option provided the product is used and maintained in accordance with the instructions. Your statutory rights are not affected.

Guarantee period = 2 years from first retail purchase.

To claim an extra 1 year guarantee, register your product online within 28 days of purchase.

Register at: **uk.russellhobbs.com/product-registration**

Consumables are guaranteed only for their recommended lifecycle. Replacement/Spare parts* are excluded and are only covered by a 1 year warranty.

* Examples include filters, removable grill plates, drip trays/crumb trays etc.

ONLINE

www.russellhobbs.com for more products