

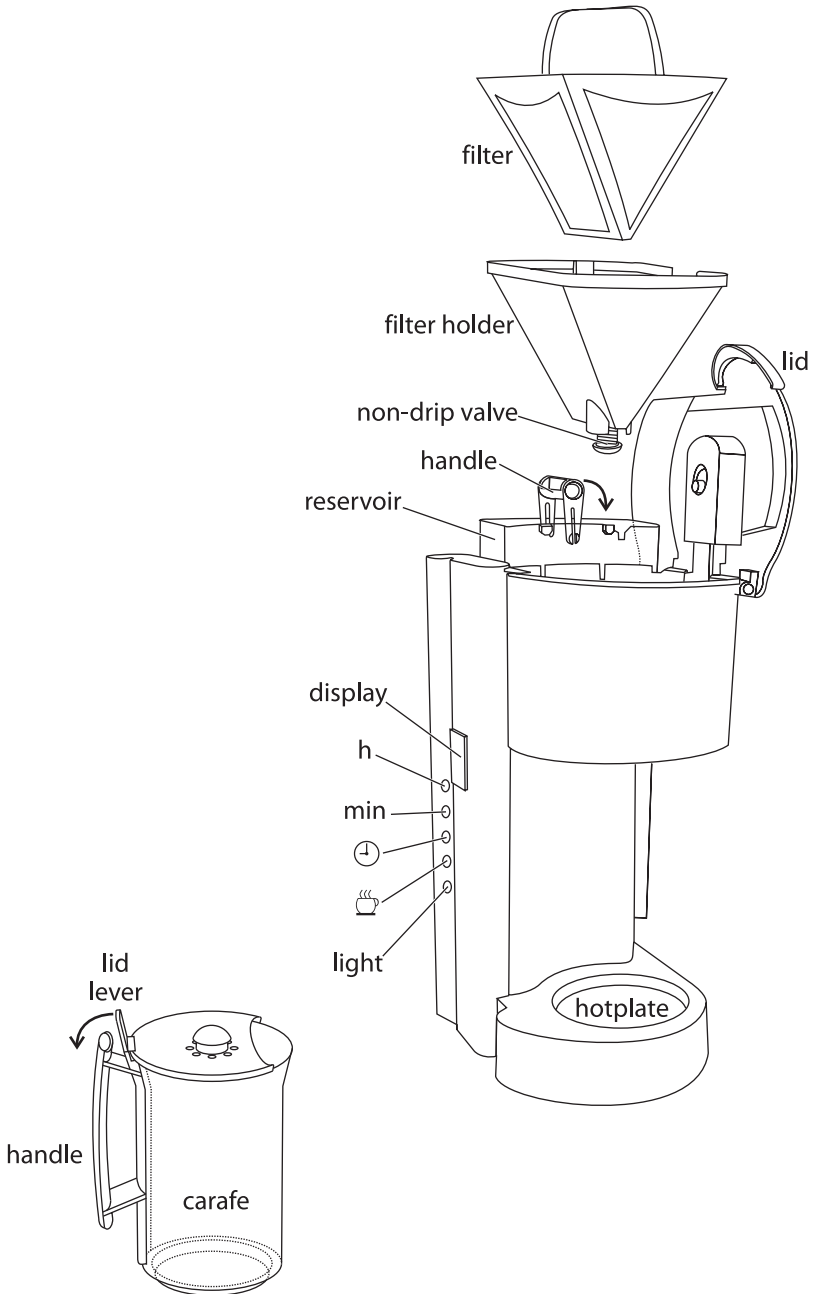

Russell Hobbs



instructions



Read these instructions before use and keep them safe. If you pass the coffee maker on, pass on the instructions too.

Remove all packaging, but keep it till you're satisfied that the coffee maker is working.

important safeguards

Follow basic safety precautions, including:

- 1 The coffee maker must only be used by or under the supervision of a responsible adult.
- 2 Don't put the coffee maker in water or any other liquid, don't use it in a bathroom or near a bathtub, basin or any other source of water, and don't use it outdoors. 
- 3 Don't touch hot surfaces e.g. carafe or hotplate. Use the handle.
- 4 Position the coffee maker on a firm, level, heat-resistant surface, close to a power socket and out of reach of children.
- 5 Take care when pouring – don't over-tilt the carafe.
- 6 Coffee will remain hot for some considerable time after the machine is switched off. This can present a scald hazard – keep the coffee maker, the carafe and the mains lead away from the edge of worktops and out of reach of children.
- 7 Route the mains lead so it doesn't overhang, and can't be tripped over or caught accidentally.
- 8 Unplug the coffee maker when not in use, before moving and before cleaning. Let it cool down fully before cleaning and storing away.
- 9 Don't fill the reservoir past the –max– mark, you won't be able to carry the reservoir without slopping water out of the top.
- 10 Put the carafe on the hotplate before switching the coffee maker on.
- 11 If you need to stop the coffee maker, press the ☞ button once if it's actually making coffee (green light), twice if it's waiting to make coffee (red light) – i.e. make the light go out.
- 12 Before adding water or reusing the coffee maker, let it cool down for 10 minutes.
- 13 Don't use the coffee maker for any purpose other than those described in these instructions.
- 14 Keep the coffee maker and mains lead away from hotplates, hobs, burners, or any other source of heat.
- 15 Don't twist or kink the mains lead, and don't wrap it round the coffee maker.
- 16 Don't put the carafe in a microwave oven.
- 17 Don't use accessories or attachments other than those we provide.
- 18 Don't use the coffee maker if it's damaged or malfunctions.
- 19 If the mains lead is damaged, return the coffee maker, in order to avoid hazard.

household use only

before using for the first time

Fill the water reservoir to the –max– mark with water and operate the coffee maker without using coffee. When the heating cycle has finished and all the water has passed into the carafe, switch the coffee maker off and unplug it. Discard the hot water and clean the coffee maker (see “care and maintenance”). This should remove any manufacturing dust, etc.

water fill

- 1 Check that the light is out. If it’s not, press the  button till it goes out (press once in manual mode, twice if **AUTO** is showing).
- 2 If it’s just been used, let the coffee maker cool down for at least 10 minutes.
- 3 Open the lid, pull up the reservoir handle, and lift the reservoir up and off the coffee maker.
- 4 Fill the reservoir with the required amount of water. Use at least 2 cups, but don’t fill it above the max mark.
- 5 Even if you only want one cup of coffee, you’ll need to put more than one cup of water into the coffee maker, to allow for evaporation, water absorbed by the coffee grounds, etc.
- 6 Sit the reservoir on the coffee maker so that the valve in the bottom of the coffee maker sits on the pipe sticking up from the bottom of the coffee maker, and the hooks at the top front of the reservoir hook over the back of the coffee maker.

coffee fill

- 7 Open the lid, and put with ground coffee into the filter. The amount will vary according to individual taste, but we suggest starting with one level tablespoonful of filter-ground coffee per cup of water.
- 8 Close the lid.

fit the carafe



- 9 Turn the carafe so the spout points away from the control panel, and sit it on the hotplate. You’ll feel some resistance as the non-drip valve is pushed up by the carafe lid.

power up

- 10 Plug the coffee maker into the power socket (switch the power socket on, if it’s switchable).
- 11 The display will show AM 12:00, flashing.

coffee now

To make coffee right away:

- 12 Press and release the hour button, to change the display and stop it flashing. It doesn’t matter what time it shows, as you’re not going to use the timer.
- 13 Press the  button
AUTO will show on the display, and the light will glow red – ignore them.
- 14 Press the  button again
the light will glow green and the coffee maker will start up.
- 15 Hot coffee will drip through the filter into the carafe.

coffee later

If you want to use the timer to make coffee later:

set the time now:

16 Press the hour and min buttons to set the display to the correct time – keep the buttons pressed to “fast forward” the display.

AM will show at the top, or **PM** at the bottom, of the display.

set the brewing time:

17 Press the  button and keep it pressed in

TIMER will show at the bottom of the display.

18 Press the hour and min buttons to set the display to the time you want the coffee to be ready – keep the buttons pressed to “fast forward” the display.

AM will show at the top, or **PM** at the bottom, of the display.

19 Release the  button

20 Press the  button once

AUTO will show on the display, and the light will glow red.

leave it alone

21 That’s it – leave it alone till the preset time comes round, and it makes your coffee – don’t fiddle with it, you might upset it

22 At the time you set, the light will change from red to green, and the coffee maker will start up.

remember

23 If you forget what time you’ve set it to, pressing the timer button will change the display to show you the time you’ve set it to.

24 Remember to press the  button after you’ve set the time, to bring **AUTO** up on the display, or the timer won’t start working.

a quick cup

If you want a quick cup of coffee before the brewing cycle has finished:

25 Remove the carafe, pour, then replace the carafe on the hotplate

26 As you remove the carafe, the non-drip valve will close automatically, to stop coffee dripping on to the hotplate.

27 To prevent the filter holder overflowing, replace the carafe within 30 seconds – this may not sound much, but you’ll find it’s more than enough time to pour a couple of cups of coffee.

28 When you replace the carafe, the non-drip valve will open again.

hotplate

29 The hotplate will keep the coffee hot for two hours – the light will stay at green to remind you it’s still on. After two hours, it’ll turn all heating off.

30 When the carafe is empty, switch the coffee maker off and unplug it from the power socket.

31 Let the coffee maker and the carafe cool down fully before cleaning or for about 10 minutes before refilling.

general

- 32 Don't keep coffee on the hotplate for more than an hour and don't reheat it otherwise it'll become bitter.
- 33 Don't try to reheat coffee by passing it through the coffee maker. The reboiled coffee won't taste very nice, and you'll damage the coffee maker.
- 34 Grease or sediment on coffee making equipment can impair the taste. Make sure the filter, filter holder, and carafe are clean before use; clean them thoroughly after each use.
- 35 Fill with freshly drawn cold water. Let the tap run for a few moments first, particularly first thing in the morning.

coffee

For best results use medium-ground filter coffee. The amount will vary with the type of coffee and your individual taste. We suggest starting with two rounded teaspoons of medium-ground coffee per cup.

milk

Our view is that personal taste should rule, not convention. What we do say is that if you like milk in your coffee, use warm or hot milk, to avoid overcooling the coffee. To extract maximum flavour from the coffee, it should be cool enough not to scald or burn the mouth, but hot enough to let the flavour fill the mouth, sinuses and nose, not just the taste buds.

bottled water

If you use bottled water, make sure it has no added ingredients, flavourings, etc., and use "still" water, not "sparkling". The carbon dioxide which gives the "sparkle" will adversely affect the flavour of your coffee.

care and maintenance

- 1 Unplug the coffee maker (switch the socket off first, if it's switchable).
- 2 Leave it to cool down fully.
- 3 Wipe the outside of the coffee maker, and the inside and outside of the filter housing with a clean damp cloth.
- 4 You can wash the carafe, filter, and filter holder in warm soapy water. Rinse thoroughly afterwards, to remove all trace of soap, then dry.
- 5 To remove the filter holder, simply lift it out of the housing. To replace it, align the tab with the open end of the housing, and drop it into place.

Don't put any part of the coffee maker in a dishwasher.

Don't put the coffee maker in water or any other liquid.

Don't use harsh or abrasive cleaners or solvents.

descaling

Scale build-up will cause the element to overheat, reducing its working life. It may cause the safety cut-out to operate prematurely, switching the coffee maker off before the water boils. It will also lengthen the brewing time.

To minimise scale build-up, empty the coffee maker after each use, don't leave water to stand in the coffee maker overnight, and descale the coffee maker regularly. Use a proprietary brand of descaler suitable for use in plastic-bodied products. Follow the instructions on the packet of descaler.

When descaling has finished, empty the carafe and operate the coffee maker twice more with fresh water only. Discard the water, to ensure no chemical residues are left. In areas of very hard water descaling may be necessary as often as once a month, and it may be necessary to use filtered water instead of ordinary tap water.

✳ Faults directly related to scale build-up aren't covered under the guarantee. They'll be subject to a repair charge

connection

The product must be earthed. It has a 13A BS1362 fuse in a 13A BS1363 plug. To replace the plug, fit the green/yellow wire to ⊕ or E, the blue wire to N, and the brown wire to L. Fit the cord grip.

If in doubt, call an electrician.

Don't use a non-rewireable/moulded plug unless the fuse cover is in place. If you remove the plug, dispose of it.

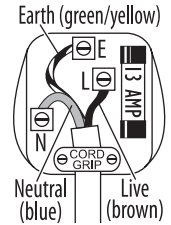

spare parts

Note the Model No (on the rating label) and the parts you need, ring 0845 658 9700 or email service@saltoneurope.com for prices, then purchase using VISA or MASTERCARD.

service

The product isn't user-serviceable. If it's not working, read the instructions, check the plug fuse and main fuse/circuit breaker. If it's still not working, consult your retailer. If that doesn't solve the problem:

Pack carefully, with a note of your name, address, day phone number, and what's wrong. If under guarantee, say where and when purchased, and include proof of purchase (till receipt). Send it to Customer Returns (address below right). They'll give you an estimate for inspection/repair.

Customer Service

(correspondence only)

Salton Europe Ltd

Failsworth

Manchester

M35 0HS

Customer Returns

Salton Europe Ltd

Heath Mill Road

Wombourne

Wolverhampton

WV5 8AQ

Customer Service (service@saltoneurope.com)

telephone 0845 658 9700 (local rate number)

guarantee

Defects affecting product functionality appearing within one year of purchase will be corrected by replacement or repair provided the product is used and maintained in accordance with the instructions. Your statutory rights are not affected.

Documentation, packaging, and product specifications may change without notice.