



Russell Hobbs



RHKM10RED_IB_RB_FA_071118
Part No. T22-9000671

5.5L KITCHEN MACHINE

2 YEAR MOTOR WARRANTY

RHKM10RED

INSTRUCTIONS & WARRANTY

IMPORTANT SAFEGUARDS

When using this appliance, basic safety precautions should always be followed, including the following:

Read all instructions before, and follow whilst using this appliance.

1. To protect against electric shock DO NOT immerse cord, plug or motor unit in water or any other liquid.
2. Do not use this appliance near bathtubs, showers, basins or other vessels containing water. 
3. Do not use outdoors.
4. This product is not intended for use by persons (including children) with reduced physical, sensory or mental capabilities, or lack of experience and knowledge, unless they have been given supervision or instruction concerning use of the product by a person responsible for their safety.
5. This appliance is not a toy. Children shall be supervised to ensure they do not play with this appliance.
6. Cleaning or user maintenance shall not be carried out by children without the supervision of a person responsible for their safety.
7. Always switch off and disconnect this appliance from the wall power outlet when not in use, before cleaning and removing attachments.
8. To disconnect, set the control to off. Turn off the wall power outlet, then grasp the plug and remove from the wall power outlet. Never pull by the cord.
9. Do not operate any appliance with a damaged cord or plug or after the appliance has malfunctioned, or has been dropped or damaged in any manner. Contact customer service for replacement, examination, repair or adjustment.
10. There are no user serviceable parts. If the power cord is damaged, it must be replaced by the manufacturer or similarly qualified person in order to avoid a hazard.
11. Switch off and unplug the appliance before changing accessories or touching parts that move whilst in use.
12. Do not leave the appliance unattended when in use.
13. Do not use on an inclined plane or unstable surface.
14. Keep the appliance and the power cord away from the edges of benches and countertops.
15. Do not place on or near any heat sources.
16. Do not use appliance for other than its intended purpose.
17. Misuse of the appliance may cause injury.
18. Do not touch the whisk, beater or dough hook while the appliance is in operation.
19. Keep fingers and utensils away from moving parts.
20. Do not operate the appliance for more than 10 minutes at a time. Allow 20 minutes rest before next use to allow the motor to cool.
21. **CAUTION:** Never process heated liquids (over 40°C) as they may be ejected due to steaming.
22. Do not use the appliance for any purpose other than those described in these instructions.
23. Do not use attachments or accessories other than those supplied with this appliance.
24. Do not use the blender at the same time as the mixer.
25. Keep the appliance and the power cord away from the edge of tables or countertops and out of reach of children and persons with reduced physical, sensory and mental capacities.

26. This appliance is not intended to be operated by means of an external timer or separate remote control system.
27. For added safety, electrical appliances should be connected to a power outlet that is protected by a residual current device (RCD / 'Safety Switch') having a rated residual operating current not exceeding 30mA. Your switchboard may already incorporate an RCD. If unsure, call an electrician for verification and fitting if necessary.
28. This appliance is intended to be used in household and similar applications such as:
- Staff kitchen areas in shops, offices and other working environments;
 - Farm houses;
 - By clients in hotels, motels, and other residential type environments;
 - Bed & breakfast type environments.

SAVE THESE INSTRUCTIONS.

Congratulations on the purchase of your new Russell Hobbs appliance. Each unit is manufactured to ensure safety and reliability.

Before using the appliance for the first time, please read this instruction booklet carefully and keep it for future reference. Pass it on if you pass on the appliance.

When using this appliance, basic safety precautions should always be followed.

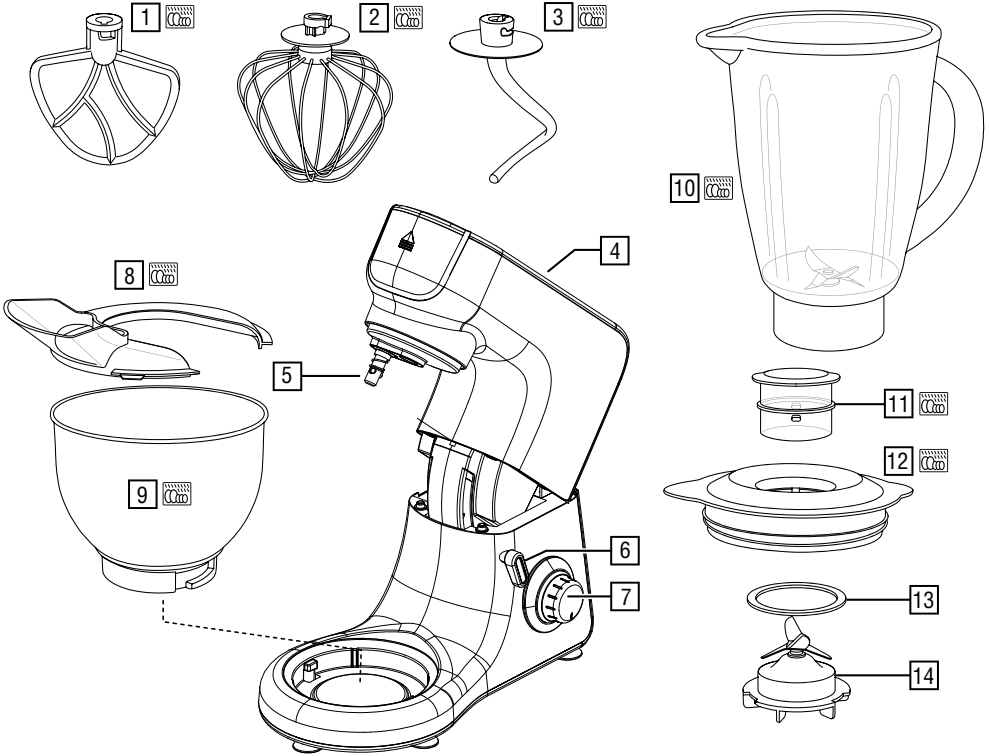

 Dishwasher safe

- | | |
|------------------------|------------------|
| 1. Beater | 8. Splash guard |
| 2. Whisk | 9. Bowl |
| 3. Dough hook | 10. Blending jug |
| 4. Arm | 11. Cap |
| 5. Drive shaft and pin | 12. Lid |
| 6. Arm lock lever | 13. Seal |
| 7. Speed dial | 14. Blade |

BEFORE FIRST USE

- Read all of the instructions included in this manual.
- Remove any packaging material and labels from the Kitchen Machine.
- All parts of the Kitchen Machine need to be thoroughly cleaned before being used for the first time. (See “Care and Maintenance” section).

PREPARATION

1. Sit the appliance on a water-resistant, dry, stable, level surface.
2. Route the cable so it doesn't overhang, and can't be tripped over or caught.
3. Don't plug the appliance in until you have finished assembling it.

GENERAL USE

RAISING THE ARM

NOTE: The blender must not be attached when raising the arm.

1. Ensure the Kitchen Machine is switched off and unplugged.
2. Turn the arm lock lever to the unlock position.
3. The arm will lift, with your assistance, allowing removal/replacement of the stainless steel bowl and/or mixing attachments.
4. At its uppermost position the arm will lock into place and the arm lock lever will return to the lock position.

LOWERING THE HEAD

CAUTION: Keep hands and items clear of the head pivoting area to avoid injury or damage to the appliance.

1. Ensure the required mixing attachment is correctly fitted and the mixing bowl is in position. (See “Fitting the Bowl” and “Fitting/Removing Attachments” sections)
2. Turn the arm lock lever to the unlock position.
3. Gently lower the arm by pressing down on the top of the Kitchen Machine until it locks into position.
4. The arm lock lever will return to the lock position.

FITTING THE BOWL

1. Raise the arm before fitting or removing the bowl.
2. Fit the bowl into the recess in the base and turn the bowl clockwise until it locks.
3. To remove, turn the bowl anti-clockwise then lift it off the base.

FITTING/REMOVING ATTACHMENTS

Switch off, unplug and raise the arm before fitting or removing attachments.

1. Align the slot in the attachment with the pin on the drive shaft (Fig A).
2. Push the attachment onto the drive shaft then turn it anti-clockwise to lock it in place (Fig B).

To remove an attachment, push the attachment upwards slightly then turn it clockwise and withdraw it from the shaft.

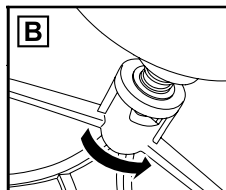
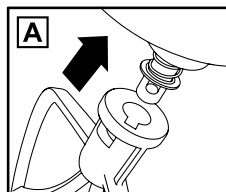

SPLASH GUARD

The splash guard protects you from spills or splashes during mixing while still allowing you to add ingredients. Switch off and unplug your mixer before fitting/removing the splash guard.

With the bowl in position and the arm in the lowered position:

1. Slide the splash guard between the arm and the bowl.
2. Align the guard so that the opening is on the same side as the speed control dial (Fig C).

NOTE: Always remove the splash guard before raising the arm.

FITTING BLENDER ATTACHMENT

NOTE: Ensure that speed control is set to 'O' (off).

1. Slide off the blending jug drive cover (Fig D).
2. Insert the jug into the drive opening with the ▼ mark on the jug aligned with the ◻ mark on the mixer (Fig E).
3. Twist the jug clockwise until the ▼ mark on the jug is aligned with the ◻ mark on the mixer (Fig F).
4. Add the ingredients to the jug and fit the lid and cap (Fig G).

CAUTION: Don't fill past the max mark on the jug. Never use the jug without the lid fitted.

USING YOUR MIXER

1. Check that the speed control is set to 'O'.
2. Put the plug into the power socket (switch the socket on, if its switchable).
3. Turn the speed control clockwise to the speed you want.
4. The range is from 1 (low) to 10 (high). Turn the speed control back to 'O' to turn the motor off.
5. To operate the motor in short bursts, turn the speed control to the 'P' position. Release the control to stop the motor.

RECOMMENDED SPEEDS

Attachment	Speed	Use for
Whisk	7-10	Egg whites, light mixes
Beater	4-7	creaming butter and sugar, medium cake mixes
Dough hook	1-4	heavy mixtures, bread, pastry

Note: Do not use blender at the same time as the mixer

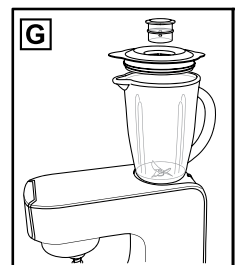
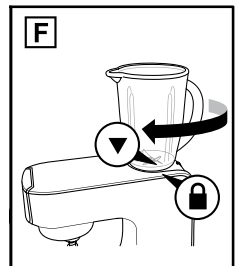
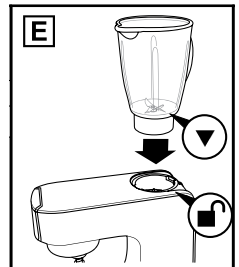
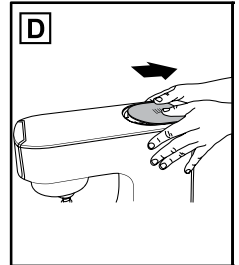
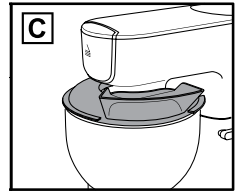

USING YOUR BLENDER

CAUTION: Ensure that all accessories are removed from mixer before turning on blender as mixer drive shaft and pin will move when blender is turned on.

1. Check that the speed control is set to 'O' and that the blender jug is correctly in place.
2. Put the plug into the power socket (switch the socket on, if its switchable).
3. Turn the speed control clockwise to the speed you want.
4. The range is from 1 (low) to 10 (high). Turn the speed control back to 'O' to turn the motor off.
5. To operate the motor in short bursts, turn the speed control to the 'P' position. Release the control to stop the motor.
6. If you need to add other ingredients during blending, turn the cap anticlockwise and lift it off. Add the ingredients then replace the cap and turn it clockwise to lock it.
7. When you have finished blending, turn the speed to control to 'O' and wait for the blades to stop before removing the lid from the jug or the jug from the mixer.
8. To remove the jug, twist it anticlockwise until the ▼ mark is aligned with the 

CAUTION: Never process heated liquids as they may be ejected due to steaming.

CARE AND MAINTENANCE

NOTE: Switch off and unplug appliance before cleaning.

MIXER:

1. Clean as soon after use as possible to prevent residues setting inside the bowl.
2. Wash the bowl, splash guard and attachments in warm soapy water, rinse, and dry.
3. You may put the bowl and attachments in a dishwasher, but note: the harsh environment inside the dishwasher will affect the surface finishes. The damage should be cosmetic only, and should not affect the operation of the appliance.
4. Wipe the outside surfaces of the appliance with a clean damp cloth.

BLENDING JUG:

1. Wash the blending jug, cap and lid in warm soapy water. Rinse and dry.
2. You may wash the jug, cap and lid in a dishwasher. However, we recommend that you remove the blade before washing in a dishwasher.

TO REMOVE BLENDING BLADE:

1. Turn the jug upside down.
2. Twist the blade clockwise in the direction of the  symbol (Fig H).
3. Carefully lift out the blade unit (Fig J).

CAUTION: Take care, the blades have very sharp edges.

4. Remove the seal and carefully wash the blade and seal in warm soapy water. Rinse and dry.
5. Refit the seal to the blade then lower the blade into the jug and twist it as far as it will go anticlockwise in the direction of the  symbol (Fig H). Make sure the seal is fitted and the blade is fully tightened otherwise the jug may leak during use.

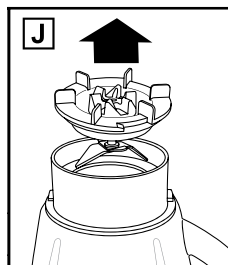
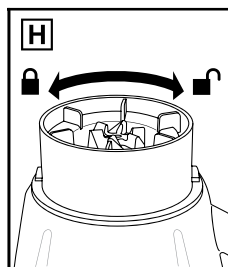

Spectrum Brands Australia Pty Ltd

Locked Bag 3004 Braeside
Victoria 3195 Australia

Customer Service in Australia

TollFree: 1800 623 118
Email: info@spectrumbrands.com.au
Website: www.spectrumbrands.com.au

Spectrum Brands New Zealand Ltd

PO Box 9817 Newmarket
Auckland 1149 New Zealand

Customer Service in New Zealand

TollFree: 0800 736 776
Email: service@spectrumbrands.co.nz
Website: www.spectrumbrands.co.nz

Spectrum Brands Australia Pty Ltd and Spectrum Brands New Zealand Ltd Warranty Against Defects

In this warranty:

Australian Consumer Law means the Australian consumer law set out in Schedule 2 to the Competition and Consumer Act 2010;

CGA means the New Zealand Consumer Guarantees Act 1993;

Goods means the product or equipment which was accompanied by this warranty and purchased in Australia or New Zealand, as the case may be;

Manufacturer, We or **us** means:

1. for Goods purchased in Australia, Spectrum Brands Australia Pty Ltd ABN, 78 007 070 573;
or
2. for Goods purchased in New Zealand, Spectrum Brands New Zealand Ltd, as the case may be, contact details as set out at the end of this warranty;

Supplier means the authorised distributor or retailer of the Goods that sold you the Goods in Australia or in New Zealand; and

You means you, the original end-user purchaser of the Goods.

1. Our goods come with guarantees that cannot be excluded under the Australian Consumer Law, or the CGA. You are entitled to a replacement or refund for a major failure and compensation for any other reasonably foreseeable loss or damage. You are also entitled to have the goods repaired or replaced if the goods fail to be of acceptable quality and the failure does not amount to a major failure.
2. The benefits provided by this Warranty are in addition to all other rights and remedies in respect of the Goods which the consumer has under either the Australian Consumer Law or the CGA. The original purchaser of the Goods is provided with the following Warranty subject to the Warranty Conditions:
3. We warrant the Goods for all parts defective in workmanship or materials for the period of 2 years from the date of purchase (**Warranty Period**).

If the Goods prove defective within the Warranty Period by reason of improper workmanship or material, we may, at our own discretion, repair or replace the Goods without charge.

Warranty Conditions

4. The Goods must be used in accordance with the manufacturer's instructions. This Warranty does not apply should the defect in or failure of the Goods be attributable to misuse, abuse, accident or non-observance of manufacturer's instructions on the part of the user. As far as the law permits, the manufacturer does not accept liability for any direct or consequential loss, damage or other expense caused by or arising out of any failure to use the Goods in accordance with the manufacturer's instructions.
 5. Exhaustible components (such as batteries, filters and brushes) of the Goods are included under this Warranty only where there is a defect in workmanship or materials used.
 6. The warranty granted under clause 3 is limited to repair or replacement only.
 7. Any parts of the Goods replaced during repairs or any product replaced remain the property of the manufacturer. In the event of the Goods being replaced during the Warranty Period, the warranty on the replacement Goods will expire on the same date as for the Warranty Period on the original Goods which are replaced.
 8. In order to claim under the warranty granted under clause 3 you must:
 - (a) Retain this warranty with your receipt/proof of purchase; and
 - (b) Return the Goods to us at the relevant address or to the Supplier by prepaid freight within the Warranty Period accompanied with (i) the legible and unmodified original proof of purchase, which clearly indicates the name and address of the Supplier, the date and place of purchase, the product name or other product serial number and (ii) this warranty.
 9. This warranty is immediately void if:
 - (a) Any serial number or appliance plate is removed or defaced;
 - (b) The Goods have been serviced or otherwise repaired by a person not authorised to do so by us or where non approved replaced parts are used.
 10. The Goods are designed for domestic use only. The Goods must be connected to the electrical voltage requirements as specified in the ratings label located on the Goods.
 11. This warranty does not cover the cost of claiming under the warranty or transport of the Goods to and from the Supplier or us.
 12. This warranty is only valid and enforceable in Australia against Spectrum Brands Australia Pty Ltd and in New Zealand against Spectrum Brands New Zealand Ltd.
- Contact us or the Supplier for further details.

Register your product online

If you live in Australia please visit: www.spectrumbrands.com.au/warranty

If you live in New Zealand Please visit: www.spectrumbrands.co.nz/warranty

Registration of your warranty is not compulsory, it gives us a record of your purchase AND entitles you to receive these benefits: Product information; Hints and tips; Recipes and news; Information on special price offers and promotions.

Any questions? Please contact Customer Service for advice.



Russell Hobbs



RHKM10RED_IB_RB_FA_071118

RECIPE BOOK

5.5L KITCHEN MACHINE

RHKM10RED

RECIPES

INGREDIENTS

150g butter

300g self raising flour

150g caster sugar

Pinch salt

75g glace cherries, chopped

1 tsp mixed spice

75g each of sultanas and raisins

3 tbsp milk

25g mixed peel

3 eggs

1. Preheat the oven to 180°C.
2. Grease a 20cm round cake tin and line with greaseproof paper.
3. Put the butter, sugar, dried fruits and spices in the bowl, and beat on speed '3' until combined slightly. Add the eggs and milk and beat for a few seconds, gradually adding the flour, and continue beating until well mixed.
4. Pour into the cake tin and bake for about 1½ hours.
5. Cool in the tin for 15 minutes then turn onto a wire rack.

www.russellhobbs.com.au

www.russellhobbs.co.nz

RUSSELL HOBBS and logo are Trade Marks of Spectrum Brands, Inc., or one of its subsidiaries.

©2018 Spectrum Brands, Inc.

Recipes are to be used in conjunction with the RHKM10RED Kitchen Machine by Russell Hobbs. All rights reserved. No part of this publication may be reproduced, stored in a retrieval system or transmitted in any form or by any means, electronic, mechanical, photocopying, recording or otherwise, without prior permission of the copyright owner.

SPONGE CAKE

BEATER

INGREDIENTS

500g plain flour	2 drops vanilla essence
1 tbsp baking powder	50g strawberry jam
250g soft butter or margarine	4 eggs
125ml milk	200g whipped cream
250g sugar	
Pinch of salt	

1. Preheat the oven to 190°C.
2. Grease and line a deep 23cm round cake tin.
3. Put everything into the bowl, mix on speed '1' for 30 seconds, then on speed '2' for 3 minutes or until combined.
4. Pour the mixture into the cake tin, and bake in the centre of the oven for 50-60 minutes.
5. Before removing the cake from the oven, test to see if it's done. Pierce the centre of the cake with a skewer. If no mixture sticks to it, the cake is cooked.
6. Turn the cake onto a wire tray and allow to cool.
7. Cut in half with a serrated bread knife. Spread the lower half with the jam and top with cream. Top with other half of sponge and serve.

VANILLA BEAN BUTTER CAKE

BEATER

INGREDIENTS

125g butter
100g caster sugar
1 vanilla bean pod
2 eggs
125g self raising flour
1 tbsp milk

1. Preheat the oven to 180°C.
2. Grease two 18cm straight sided sandwich tins and line with greaseproof paper.
3. Split the vanilla pod, and scrape out the seeds with a knife. Put the butter, sugar and vanilla seeds in the bowl, and beat on speed '1' for a few seconds. Add one of the eggs, mix well on speed '2', and then add half the flour. Repeat, adding eggs and flour until all the ingredients are combined and smooth in texture.
4. Divide into the two tins and bake in the centre of the oven for 20-25 minutes.
5. Cool on a wire rack. Fill with butter cream or whipped cream and jam.

TREACLE PUDDING

BEATER

INGREDIENTS

100g caster sugar	100g butter
5 tbsp golden syrup	100g self raising flour
2 eggs	Extra butter for greasing

1. Grease a 900ml pudding basin and set aside.
2. Put the butter and sugar in the bowl and beat on speed '2' or '3' until light and fluffy. Add one egg, then a little flour, then the other egg, and then mix in the remaining flour.
3. Put the syrup into the greased pudding basin, and pour the mixture on top.
4. Cover with greaseproof paper or foil, secure with string and steam for 1½-2 hours.
5. Serve hot with custard or cream.

CHOCOLATE CAKE

BEATER

INGREDIENTS

1 1/3 cups plain flour	1 cup buttermilk
1 tsp bicarbonate of soda	2 eggs
1/3 cup cocoa powder	125g butter, melted, cooled
1 cup caster sugar	1 tsp vanilla essence

1. Preheat the oven to 180°C.
2. Grease and line a deep 20cm round cake tin.
3. Sift flour, bicarbonate of soda and cocoa powder into the bowl. Add the sugar.
4. Combine buttermilk, eggs, melted butter and vanilla in a jug.
5. Make a well in centre of flour mixture, and pour in buttermilk mixture.
6. Begin to mix on speed '1' or '2' until combined. Then increase to speed '4', and beat for 3 to 4 minutes or until thick and creamy.
7. Pour mixture into prepared pan. Bake for 40 to 45 minutes or until a skewer inserted in the centre comes out clean.
8. Allow to cool in pan for 5 minutes. Turn out onto a wire rack to cool completely.

BASIC MERINGUES

WHISK

INGREDIENTS

4 egg whites
100g caster sugar
100g icing sugar

1. Preheat the oven to 120°C
2. Combine the sugars and set aside. Whisk the egg whites in the bowl on speed '5' until fairly stiff. Add half the sugar and whisk until smooth and stiff peaks have formed.
3. Remove the bowl, and lightly fold in the remaining sugar with a metal spoon.
4. Line a tray with baking paper, and spoon or pipe the meringue mixture into ovals, then sprinkle with the remaining sugar.
5. Cook on the lowest shelf of the oven for 1½ hours. Cool on a wire rack.
6. Serve as they are or top with soft fruits, grated chocolate, or sweetened cream.

HOT CHOCOLATE SOUFFLÉ

WHISK

INGREDIENTS

75g butter	4 eggs, separated
450ml milk	3 tbsp cocoa powder
50g plain flour	50g caster sugar

1. Preheat the oven to 190°C
2. Melt the butter in a pan, stir in the flour and cocoa, and blend over a low heat. Add the milk and mix well until thickened slightly. Remove from the heat and set aside to cool, then add the egg yolks and beat in.
3. Put the egg whites in the bowl, mix on speed '6' for a few seconds, then add the sugar and continue to whisk until soft peaks form. Fold in the sauce.
4. Pour the mixture into a greased 1.2 litre dish. Stand the dish in a roasting tin filled half full with boiling water, put into the oven, and bake for 40-45 minutes, until well risen.

ITALIAN HERB BREAD

DOUGH HOOK

Makes a 1kg loaf

INGREDIENTS

575g bakers white bread flour	2 tsp salt
2 tsp sugar	290ml lukewarm water (30°-35°C)
1 sachet active dried yeast (about 2½ tsp)	4 tbsp mixed dried herbs
	2 tbsp olive oil

1. Preheat the oven to 200°C
2. Mix the water, oil, sugar, salt and yeast in a jug or bowl, and leave for 5 minutes.
3. Put the flour and dried herbs in the bowl, and mix on speed '1', gradually adding the liquid, then increase the speed to '2' and mix for 5 minutes. Put the dough in a bowl, cover and leave in a warm place until doubled in size (20-30 minutes).
4. Put on a floured surface and knead gently to knock out the air, then shape. Place on greaseproof baking paper and leave in a warm place until doubled in size.
5. Bake until golden brown and hollow sounding on the bottom.

BASIC WHOLEMEAL BREAD

DOUGH HOOK

Makes a 1kg loaf

INGREDIENTS

575g bakers wholemeal bread flour	1 tbsp light brown sugar
2 tbsp sunflower oil or butter	375ml warm water
1 sachet active dried yeast (about 2½ tsp)	2 tsp salt

1. Preheat the oven to 200°C
2. Put the dry ingredients in the bowl and mix gently with a wooden spoon. Gradually add the liquid and mix on speed '1'. As the ingredients incorporate, and the dough ball becomes more formed, increase the speed to '2'. Knead for a couple of minutes on this speed, until the dough ball is smooth.
3. Put the dough in a bowl, cover and leave in a warm place until it has doubled in size (30-40 minutes).
4. Remove the dough and punch down to remove air. Knead lightly on a floured board, shape it into a loaf, or put it in a tin, cover, and leave in a warm place to rise for another 30 minutes.
5. Bake for 25-30 minutes or until golden brown and hollow sounding on the bottom.

SOFT POPPY SEED ROLLS

DOUGH HOOK

Makes 8-10

INGREDIENTS

570g bakers white bread flour	300ml milk, warmed slightly
1 tbsp sunflower oil	2 tsp salt
1 sachet active dried yeast (about 2½ tsp)	2 eggs (room temperature)
1½ tsp sugar	75g poppy seeds

1. Preheat the oven to 220°C
2. Mix the milk, eggs, oil, sugar, salt and yeast in a jug or bowl, and leave for 5 minutes.
3. Put the flour and poppy seeds in the bowl, and mix on speed '1', gradually adding the liquid, then increase the speed to '2' and mix for five minutes.
4. Remove the dough to a floured surface, cut into 8-10 pieces, and roll into shape. Place on greaseproof baking paper and leave in a warm place until doubled in size.
5. Brush with a little egg or milk, and bake for 20-25 minutes until golden brown and hollow sounding on the bottom.

CURRANT LOAF

DOUGH HOOK

Makes a 1kg loaf

INGREDIENTS

500g wholemeal flour	2 eggs (medium)
150g currants	½ tsp salt
150g butter, softened	2 tbsp milk
50g mixed peel	150g sugar
1 tbsp baking powder	

1. Preheat the oven to 180°C.
2. Place the flour in the bowl, add the softened butter, and mix on speed '1'. When the butter and flour start to blend, add the sugar, salt, currants, peel and baking powder.
3. Leave it mixing while you beat the eggs and milk together, and then add the egg/milk mixture to the bowl. Increase the speed to '2' and mix until all the ingredients are combined.
4. Put into a greased loaf tin and bake for 30-35 minutes, or until golden brown.
5. Turn onto a wire rack and allow to cool before slicing.

BASIC WHITE BREAD

DOUGH HOOK

Makes a 1kg loaf

INGREDIENTS

600g bakers white bread flour	1 tsp sugar
1 tbspsunflower oil or butter	345ml warm water
1 sachet active dried yeast (about 2½ tsp)	2 tsp salt

1. Preheat the oven to 200°C.
2. Put the dry ingredients in the bowl and mix gently with a wooden spoon. Gradually add the liquid and mix on speed '1'. As the ingredients incorporate, and the dough ball becomes more formed, increase the speed to '2'. Knead for a couple of minutes on this speed, until the dough ball is smooth.
3. Put the dough in a bowl, cover and leave in a warm place until it has doubled in size (30-40 minutes).
4. Remove the dough and punch down to remove air. Knead lightly on a floured board, shape it into a loaf, or put it in a tin, cover, and leave in a warm place to rise for another 30 minutes.
5. Bake for 25-30 minutes or until golden brown and hollow sounding on the bottom.

PIZZA DOUGH

DOUGH HOOK

INGREDIENTS

400g plain flour	½ tsp sugar
1½ tbspsunflower oil	250ml warm water
1 sachet active dried yeast (about 2½ tsp)	1 tsp salt

1. Preheat the oven to 200°C.
2. Put the dry ingredients in the bowl and mix gently with a wooden spoon. Gradually add the liquid and mix on speed '1'. As the ingredients incorporate, and the dough ball becomes more formed, increase the speed to '2'. Knead for a couple of minutes on this speed, until the dough ball is smooth.
3. Remove from the bowl and split into 2-4 pieces. Roll into pizza bases (circles or rectangles) on a floured surface, then lay them on a baking sheet or pizza tray.
4. Spread the pizza bases with tomato purée and add toppings – mushrooms, ham, olives, sun dried tomatoes, spinach, artichoke, etc. Top with dried herbs, pieces of mozzarella, and a drizzle of olive oil.
5. Bake for 15-20 minutes, until the toppings are bubbling and golden brown.

CORIANDER PESTO

BLENDER

INGREDIENTS

4 handfuls fresh coriander leaf
4 cloves fresh garlic
120g pine nuts
50ml olive oil
120g freshly grated Parmesan

1. Put the coriander, garlic and pine nuts in the jug, add a spoon of oil, and process.
2. Repeat till the oil's done, transfer to a big bowl, and mix in the Parmesan.
3. Season with black pepper.
4. Serve as a topping for soup, tossed through warm pasta, or as a dip.

BLACK OLIVE AND ANCHOVY SAUCE

BLENDER

INGREDIENTS

250g pitted black olives
60g anchovy fillets, drained
45g capers, drained
150ml olive oil
10ml brandy (optional)
fresh ground black pepper

1. Put everything but the oil into the bowl.
2. Add a spoon oil and process for 5 seconds.
3. Repeat till the consistency is as you want it.
4. Toss through warm pasta or spread on toast.

SWEET AND SOUR SAUCE

BLENDER

INGREDIENTS

4 shallots, peeled
small piece fresh ginger, peeled
2 cloves garlic
30ml soy sauce
dash white wine vinegar
10ml mustard
10ml tomato purée

1. Put everything into the jug and process till smooth.
2. Serve with chicken or fish, or as a dip.

SPICY PUMPKIN SOUP

BLENDER

INGREDIENTS

900g pumpkin
2 leeks, trimmed and sliced
900ml chicken or vegetable stock
30ml vegetable oil
2 cloves garlic, crushed
5g ground ginger
5g ground coriander
bunch of fresh coriander leaves
30ml single cream or crème fraîche
salt and pepper

1. Peel the pumpkin, remove the seeds, and cut the flesh into chunks. Roughly chop the coriander.
2. Heat the oil in a pan, add the leeks, garlic and spices, then stir till the leeks have softened slightly.
3. Add the pumpkin and stock to the pan, bring to the boil, then simmer gently till the pumpkin is tender (20-30 minutes).
4. Remove from the heat, and stir in the coriander and cream.
5. Let the mixture cool for about 30 minutes, then blend at high speed, till it's really smooth.
6. Return the mixture to the pan and heat to serving temperature (don't let it boil). Taste, adjust the seasoning, and serve with crusty bread.

LEEK AND POTATO SOUP (SERVES 4)

BLENDER

INGREDIENTS

150g leeks, trimmed
150g potatoes, peeled
2 vegetable or chicken
800ml water
salt and pepper to taste stock cubes

1. Blend the leeks and potatoes for a couple of seconds (you want them lumpy, not mushy).
2. Transfer to a pan, and add the water and stock cubes.
3. Bring to the boil, stirring, reduce the heat, cover the pan and simmer for 20 minutes.
4. Let the mixture cool for about 30 minutes, then blend at high speed, till it's smooth and silky.
5. Return the mixture to the pan and heat to serving temperature (don't let it boil). Taste, adjust the seasoning, and serve with crusty bread.

CAUTION: Never process heated liquids (over 40°C) as they may be ejected due to steaming.

BREAKFAST SMOOTHIE

BLENDER

INGREDIENTS

4 tbsp natural yogurt

200ml milk

30g oatmeal or porridge

1 large banana, roughly chopped

10ml honey

2 apples, cored, roughly chopped

1. Put everything into the jug. Run at speed '2' for 10 seconds, then at speed '5' for 15 seconds.

NUTTY BANANA SMOOTHIE

BLENDER

INGREDIENTS

150g hazelnut yogurt

1 large banana, roughly chopped

200ml milk

1. Put everything into the jug. Run at speed '2' for 10 seconds, then at speed '5' for 5 seconds.

MANGO LASSI

BLENDER

INGREDIENTS

200ml natural yogurt

1 ripe mango, stoned, peeled, roughly chopped

200ml milk

10ml honey

1. Put everything into the jug. Run at speed '2' for 10 seconds, then at speed '5' for 5 seconds.

CHOCOLATE ORANGE SMOOTHIE

BLENDER

INGREDIENTS

170g chocolate ice cream

300ml orange juice

1. Put everything into the jug. Run at speed '2' for 10 seconds, then at speed '5' for 5 seconds.

CHOCOLATE PEAR SMOOTHIE

BLENDER

INGREDIENTS

300ml chocolate milk

2 pears, peeled, cored, roughly chopped

1. Put everything into the jug. Run at speed '2' for 15 seconds, then at speed '5' for 5 seconds.

STRAWBERRY AND BANANA SMOOTHIE

BLENDER

INGREDIENTS

300ml milk

1 large banana, roughly chopped

12 strawberries, stalks removed

1. Put everything into the jug. Run at speed '2' for 10 seconds, then at speed '5' for 10 seconds.

BANANA, VANILLA AND HONEY SMOOTHIE

BLENDER

INGREDIENTS

400ml milk

1 large banana, roughly chopped

20ml honey

10ml vanilla extract

1. Put everything into the jug. Run at speed '2' for 10 seconds, then at speed '5' for 5 seconds.

APPLE AND MANGO SMOOTHIE

BLENDER

INGREDIENTS

600ml apple juice

1 ripe mango

1. Stone, peel and roughly chop the mango. Put everything into the jug. Run at speed '2' for 10 seconds, then at speed '5' for 10 seconds.

CREAMY BLUEBERRY AND VANILLA SMOOTHIE

BLENDER

INGREDIENTS

360ml lemonade

125g vanilla ice cream

70g blueberries

1. Put everything into the jug. Run at speed '2' for 10 seconds, then at speed '5' for 10 seconds.

CRANBERRY, ORANGE AND BANANA SMOOTHIE

BLENDER

INGREDIENTS

300ml orange juice

300ml cranberry juice

1 small banana, roughly chopped

1. Put everything into the jug. Run at speed '2' for 10 seconds, then at speed '5' for 5 seconds.

PEACH AND APRICOT SMOOTHIE

BLENDER

INGREDIENTS

4 halves of tinned apricot (in juice)

80ml apricot juice (from tin)

2 peaches

60ml natural yogurt

200ml milk

10ml honey

1. Stone and roughly chop the peaches. Put everything into the jug. Run at speed '2' for 15 seconds, then at speed '5' for 15 seconds.

BERRY FRUITY SMOOTHIE

BLENDER

INGREDIENTS

300ml apple juice

90g raspberries

12 strawberries, stalks removed

1. Put everything into the jug. Run at speed '2' for 15 seconds, then at speed '5' for 15 seconds.

APPLE, MELON AND KIWI FRUIT SMOOTHIE

BLENDER

INGREDIENTS

400ml apple juice

1 kiwi fruit, peeled and roughly chopped

150g melon, roughly chopped

1. Put everything into the jug. Run at speed '2' for 10 seconds, then at speed '5' for 10 seconds.

VERY CHOCOLATEY CHERRY SMOOTHIE

BLENDER

INGREDIENTS

350ml lemonade

125ml chocolate ice cream

100g cherries, stoned

1. Put everything into the jug. Run at speed '2' for 10 seconds, then at speed '5' for 10 seconds.

